

# Bordillos

Es un elemento de forma prismática, macizo y con una sección transversal condicionada por el uso de las superficies exteriores de distinta naturaleza a las que delimita.



breinco

# BORDILLO RECTO

# breinco

REVISIÓN

1

05/2021

BARCELONA 100 x 23 x 24 cm

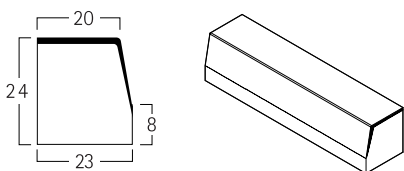

T1 100 x 12 x 20 cm

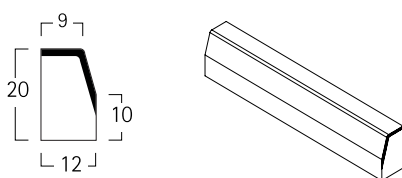

T2 100 x 15 x 25 cm

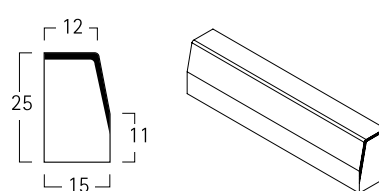

T3 100 x 17 x 28 cm

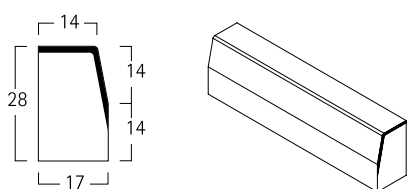

T5 100 x 22 x 30 cm

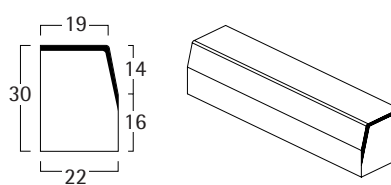

## Detalle colocación

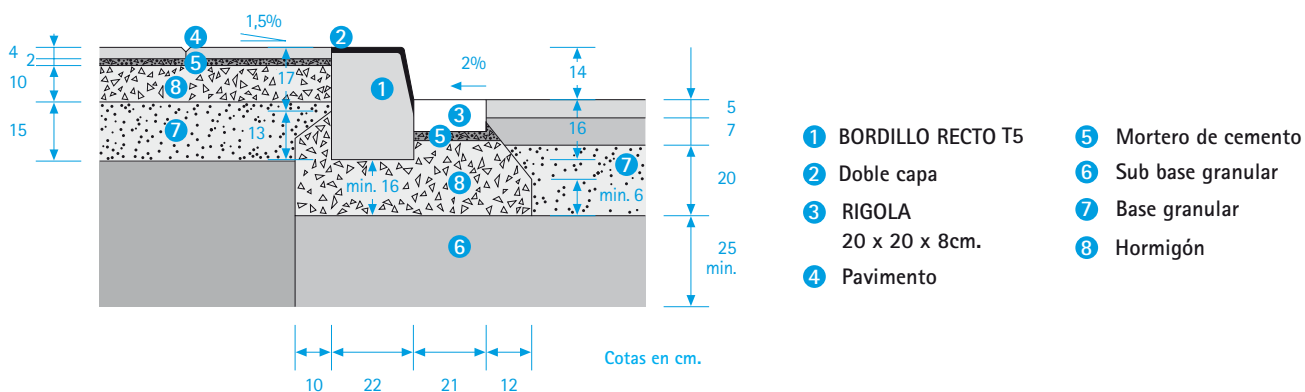

## Acabados

standard



Petra top complete

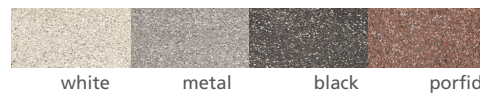

breincosmart



breincocycle

# BORDILLO ESPECIAL

# breinco

REVISIÓN

1

05/2021

TR13 50 x 25 x 13 cm

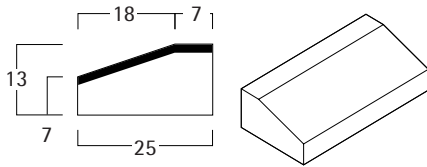

TR 37 50 x 37 x 25 cm

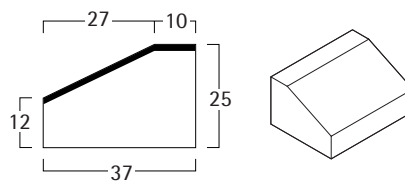

TR 20 50 x 20 x 20 cm

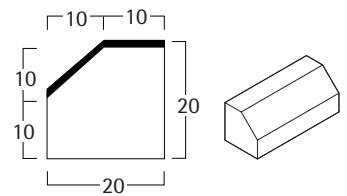

TR 25 50 x 25 x 28 cm

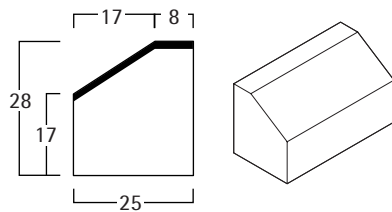

TR 30 50 x 30 x 20 cm

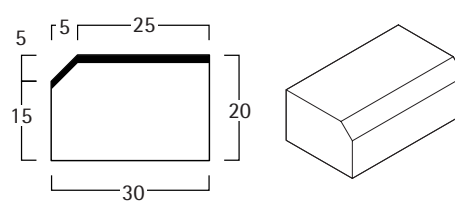

## Detalle colocación

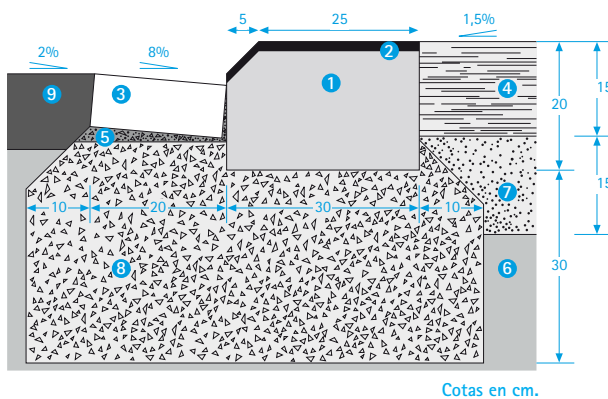

1 BORDILLO ESPECIAL TR30

2 Doble capa

3 RIGOLA 20 x 20 x 8cm.

4 Hormigón lavado

Cotas en cm.

5 Mortero de cemento

6 Sub base granular

7 Base granular

8 Hormigón

9 Asfalto

## Acabados

standard



grey



breincosmart



# BORDILLO JARDÍN

# breinco

REVISIÓN

1

05/2021

TJ7 50 x 7 x 25 cm

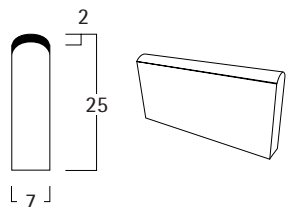

TJ8 100 x 8 x 20 cm

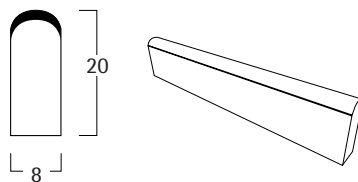

P2 100 x 8 x 20 cm

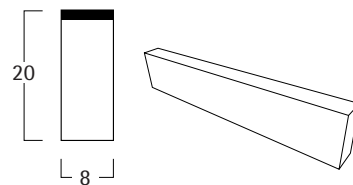

P1 100 x 8 x 20 cm

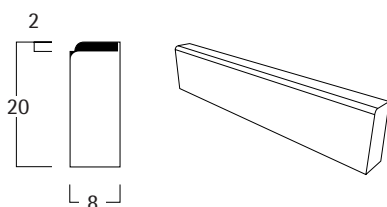

F8 100 x 8 x 20 cm

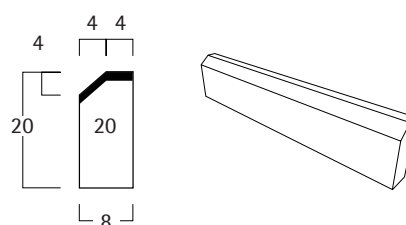

## Detalle colocación

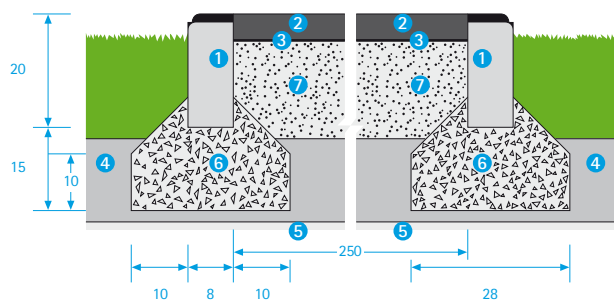

Cotas en cm.

- 1 BORDILLO JARDÍN P1
- 2 Mezcla bituminosa en caliente 5cm.
- 3 Riego de imprimación
- 4 Sub base granular 15cm.
- 5 Terraplen compactado 95% P.M.
- 6 Hormigón
- 7 Zahorra artificial 15cm.

## Acabados

standard

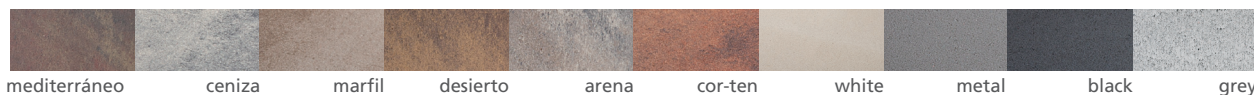

breincosmart



# BORDILLO JARDÍN

# breinco

REVISIÓN

1

05/2021

f8/72 f8/82 f8/92 f8/112

72 x 8 x 20 cm  
82 x 8 x 20 cm  
92 x 8 x 20 cm  
112 x 8 x 20 cm

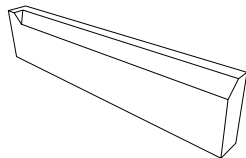
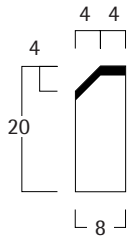

TJ 15 100 x 15 x 30 cm

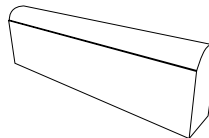
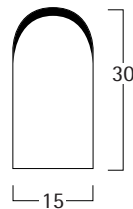

T2P 100 x 15 x 25 cm

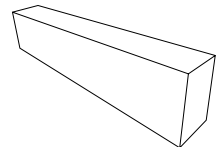
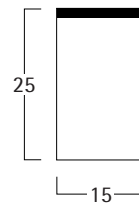

F15 100 x 15 x 30 cm

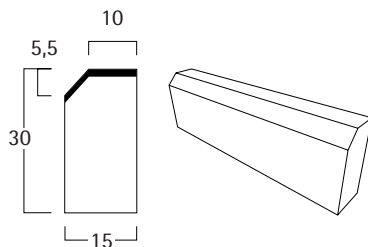

TJ20P 100 x 20 x 20 cm

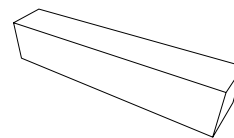
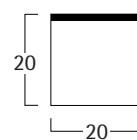

## Detalle colocación

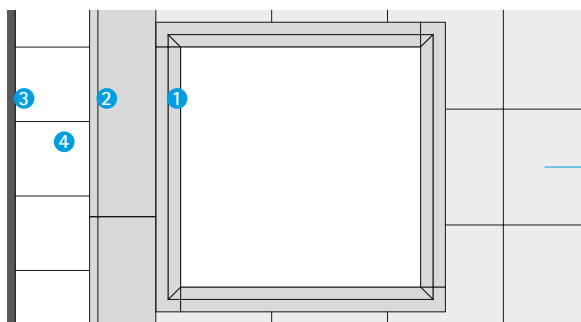

Cotas en cm.

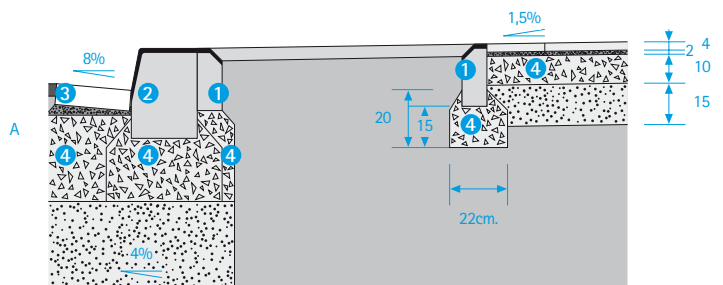

1 BORDILLO ALCORQUE  
2 BORDILLO RECTO

3 RIGOLA  
4 Hormigón

## Acabados

standard

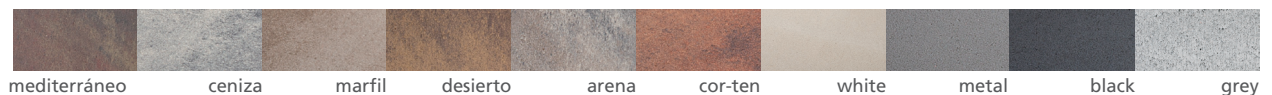

breincosmart



# BORDILLO ESCUADRA

# breinco

REVISIÓN

1

05/2021

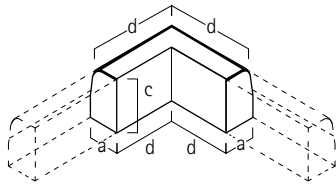

convexa t2

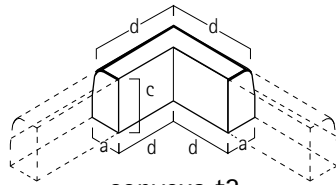

convexa t3

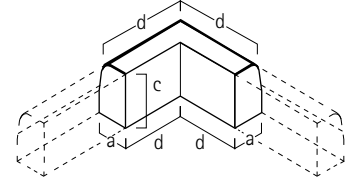

convexa t5

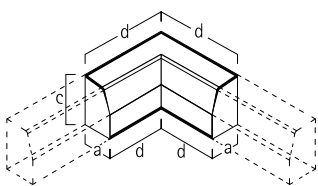

cóncava t2

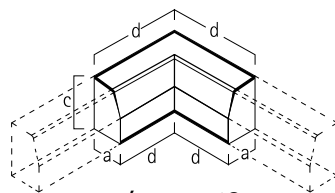

cóncava t3

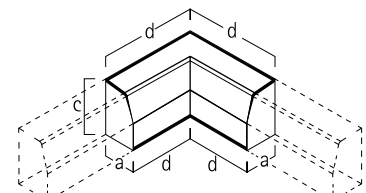

cóncava t5

## Detalle colocación

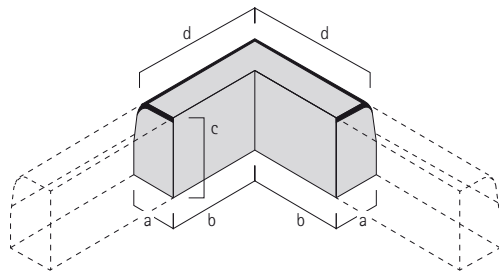

Convexo

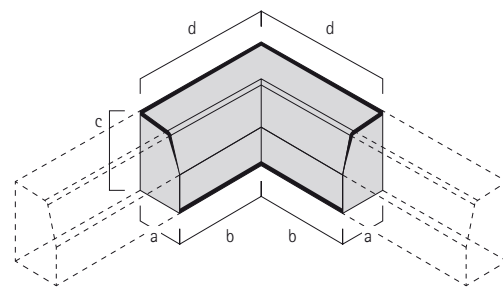

Cóncavo

## Acabados

standard

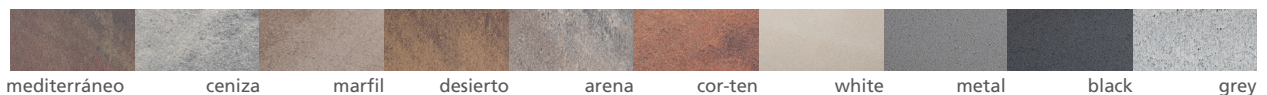

Petra

top complete

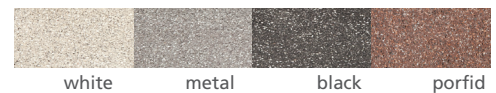

breincosmart



# BORDILLO IMBORNAL

# breinco

REVISIÓN

1

05/2021

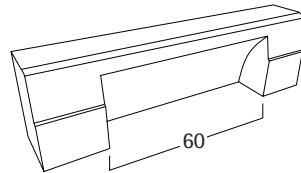

100 x 15 x 25 cm  
para t2

100 x 17 x 28 cm  
para t3

100 x 22 x 30 cm  
para t5

## Detalle colocación

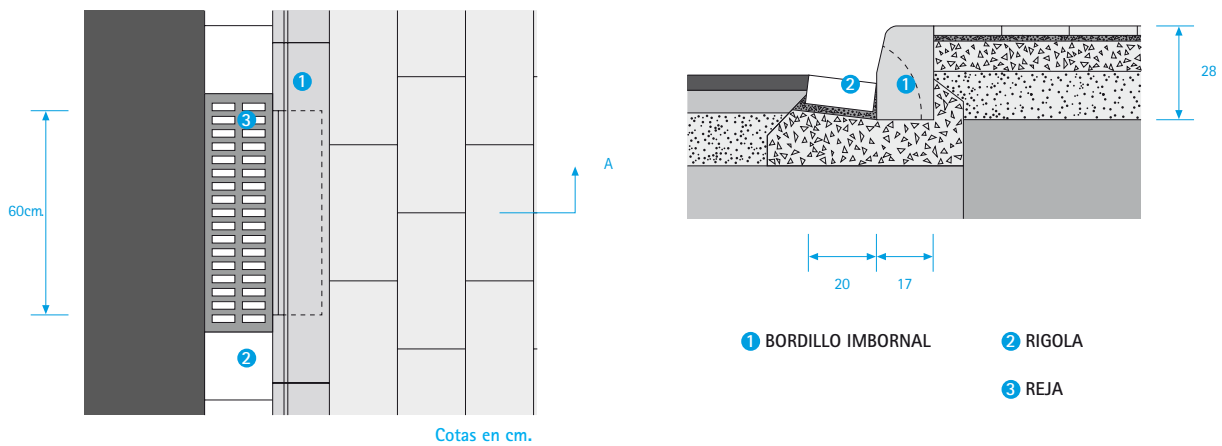

## Acabados



breincosmart

